

Cree® Direct Attach™ DA2432™ LEDs

CxxxDA2432-Sxx00-x

Data Sheet

Cree's Direct Attach™ DA2432™ LEDs are the next generation of solid-state LED emitters that combine highly efficient InGaN materials with Cree's proprietary device technology and silicon-carbide substrates to deliver superior value for the LCD backlighting and general-illumination markets. The DA2432 LEDs are among the brightest in the top-view market while delivering a low forward voltage, resulting in a very bright and highly efficient solution. The bondpad-down design allows for eutectic die attach, eliminating the need for wire bonds, and enables superior performance from improved thermal management. The design is optimally suited for industry-standard top-view packages.

FEATURES

- Direct Attach LED Technology, no wire bonding
- High Reliability - Eutectic Attach
- Junction-Down for Improved Thermal Management
- Direct Attach LED RF Performance:
 - 450 nm - 33+ mW
 - 460 nm - 33+ mW
 - 470 nm - 30+ mW
 - 527 nm - 13+ mW
- Low Forward Voltage (Vf) - 3.1 V Typical at 20 mA
- Maximum DC Forward Current - 100 mA
- Backside Metal versions for various attach methods:
 - A (AuSn) for standard profile Flux Eutectic Attach

APPLICATIONS

- General Illumination
 - White LEDs
 - Chip-on-Board (COB)
 - Multi-chip Arrays
 - High Voltage Arrays
- LCD Backlighting
 - Television
 - Monitors
 - Portable PCs & Tablets
- LED Video Displays

CxxxDA2432-Sxx00-x Chip Diagram

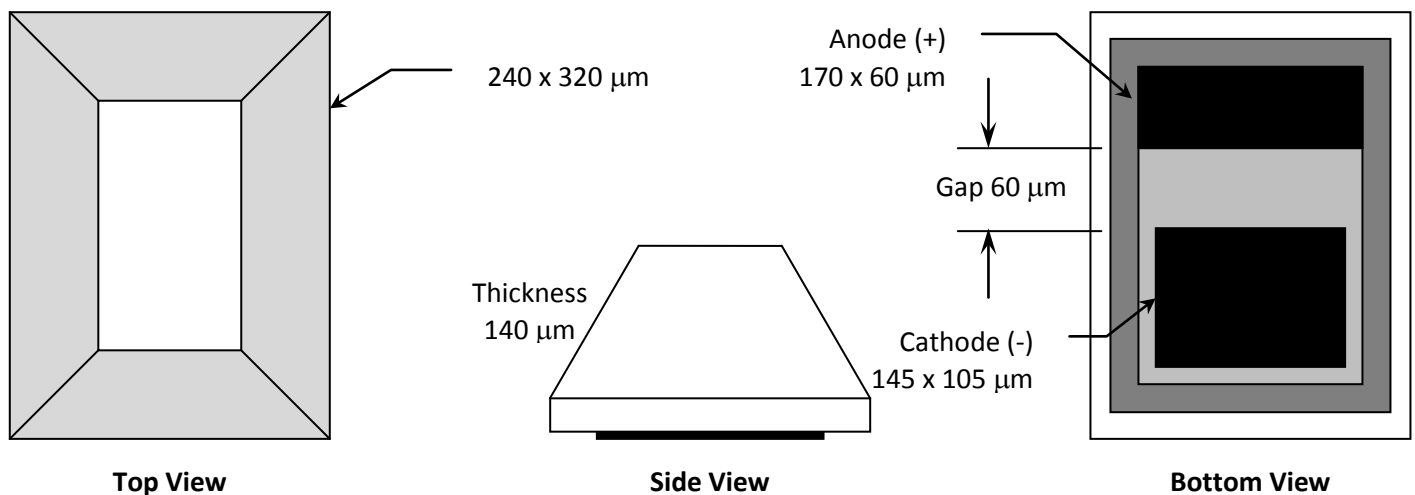

Maximum Ratings at $T_A = 25^\circ\text{C}$ <small>Notes 1,3, & 4</small>		CxxxDA2432-Sxx00-x
DC Forward Current		100 mA
Peak Forward Current (1/10 duty cycle @ 1 kHz)		150 mA
LED Junction Temperature		150°C
Reverse Voltage		5 V
Operating Temperature Range		-40°C to +100°C
LED Chip Storage Temperature		-40°C to +120°C
Recommended Die Sheet Storage Conditions		$\leq 30^\circ\text{C}$ / $\leq 85\%$ RH
Electrostatic Discharge Threshold (HBM) <small>Note 2</small>		2000 V
Electrostatic Discharge Classification (MIL-STD-883E) <small>Note 2</small>		Class 2

Typical Electrical/Optical Characteristics at $T_A = 25^\circ\text{C}$, $I_f = 20\text{ mA}$ <small>Note 3</small>					
Part Number	Forward Voltage (V_f , V)			Reverse Current [$I(V_r=5V)$, μA]	Full Width Half Max (λ_D , nm)
	Min.	Typ.	Max.	Max.	Typ.
C450DA2432-Sxx00-x	2.8	3.1	3.4	2	20
C460DA2432-Sxx00-x	2.8	3.1	3.4	2	21
C470DA2432-Sxx00-x	2.8	3.1	3.4	2	21
C527DA2432-Sxx00-x	2.9	3.2	3.5	2	35

Mechanical Specifications			CxxxDA2432-Sxx00-x
Description	Dimension	Tolerance	
P-N Junction Area (μm)	210 x 280	± 35	
Chip Bottom Area (μm)	240 x 320	± 35	
Chip Top Area (μm)	110 x 190	± 35	
Chip Thickness (μm)	140	± 15	
Bond Pad Width – Anode (μm)	60	± 15	
Bond Pad Length – Anode (μm)	170	± 35	
Bond Pad Width – Cathode (μm)	105	± 35	
Bond Pad Length – Cathode (μm)	145	± 35	
Bond Pad Gap (μm)	60	± 15	
Bond Pad Thickness (μm) - "-A" (AuSn)	3.0	± 0.5	

Notes:

- Maximum ratings are package-dependent. The above ratings were determined using a chip sub-mount on MCPCB (with silicone encapsulation and flux eutectic die attach) for characterization. Ratings for other packages may differ. Junction temperature should be characterized in a specific package to determine limitations. Assembly processing temperature must not exceed 325°C (< 5 seconds).
- Product resistance to electrostatic discharge (ESD) according to the HBM is measured by simulating ESD using a rapid avalanche energy test (RAET). The RAET procedures are designed to approximate the maximum ESD ratings shown. The ESD classification of Class 2 is based on sampling testing according to MIL-STD-883E.
- All products conform to the listed minimum and maximum specifications for electrical and optical characteristics when assembled and operated at 50 mA within the maximum ratings shown above. Efficiency decreases at higher currents. Typical values given are within the range of average values expected by manufacturer in large quantities and are provided for information only. All measurements are based on a thru-hole package (with Hysol™ OS4000 encapsulant and flux eutectic die attach). Optical characteristics are measured in an integrating sphere using Illuminance E.
- The maximum forward current is determined by the thermal resistance between the LED junction and ambient. It is crucial for the end-product to be designed in a manner that minimizes the thermal resistance from the LED junction to ambient in order to optimize product performance.

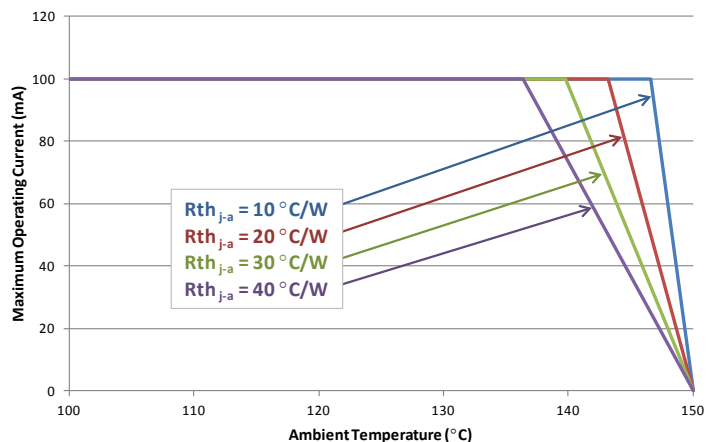

Standard Bins for CxxxDA2432-Sxx00-x

LED chips are sorted to the **radiant flux** and **dominant wavelength** bins shown. A sorted die sheet contains die from only one bin. Sorted die kit (CxxxDA2432-Sxxxx-x) orders may be filled with any or all bins (CxxxDA2432-xxxx-x) contained in the kit. All radiant flux and dominant wavelength values shown and specified are at $I_f = 20 \text{ mA}$.

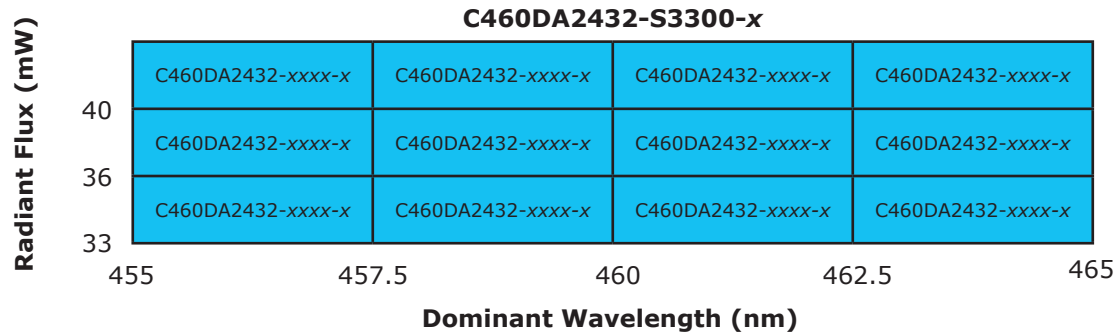
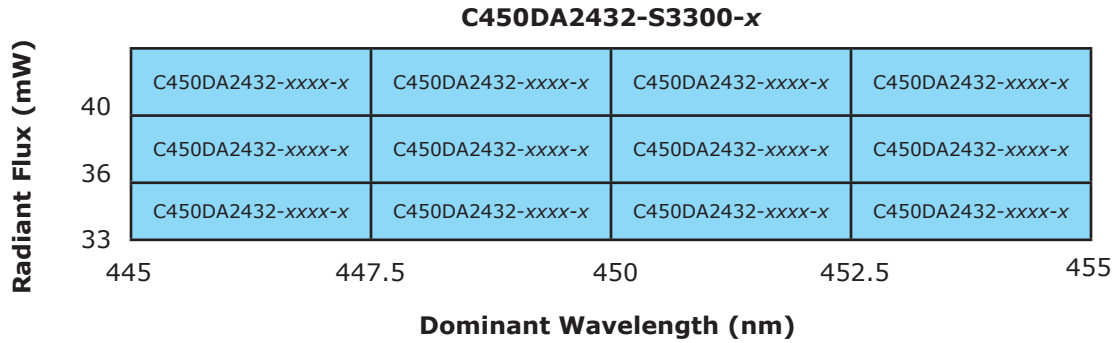

Standard Bins for CxxxDA2432-Sxx00-x

LED chips are sorted to the **radiant flux** and **dominant wavelength** bins shown. A sorted die sheet contains die from only one bin. Sorted die kit (CxxxDA2432-Sxxxx-x) orders may be filled with any or all bins (CxxxDA2432-xxxx-x) contained in the kit. All radiant flux and dominant wavelength values shown and specified are at $I_f = 20$ mA.

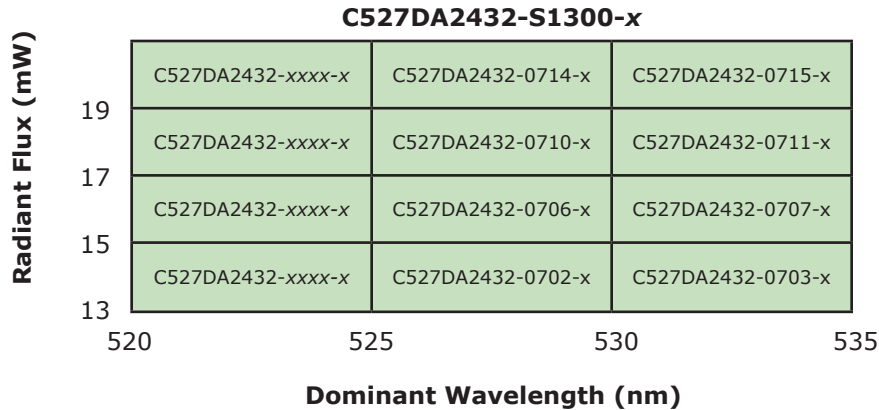
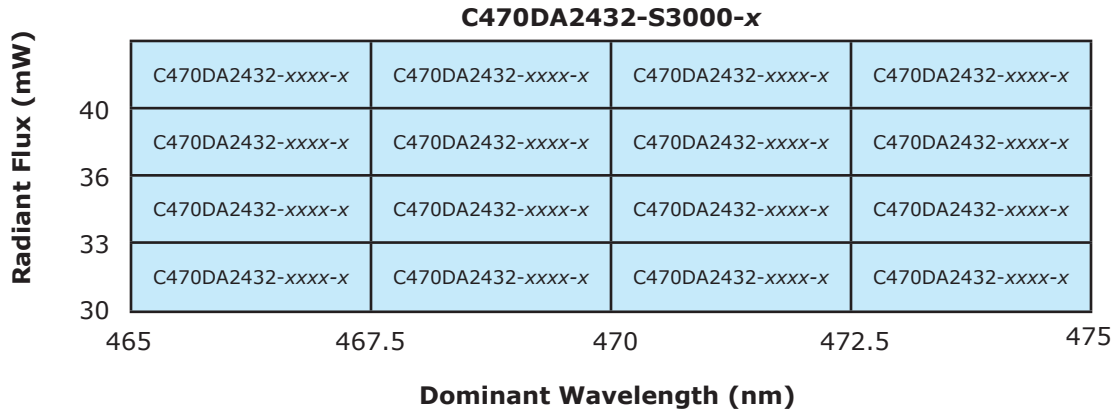

Characteristic Curves

These are representative measurements for the DA2432 LED product. Actual curves will vary slightly for the various radiant flux and dominant wavelength bins.

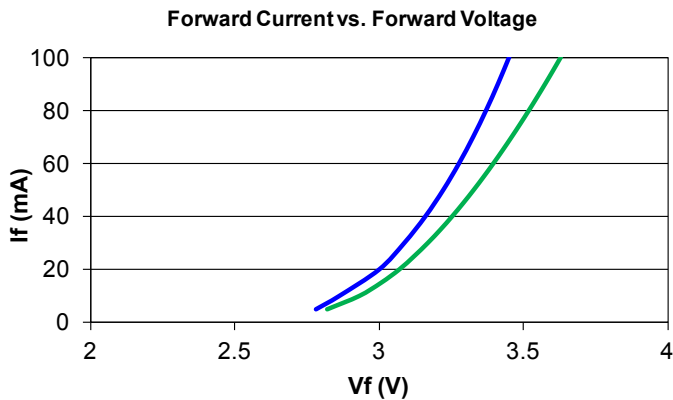
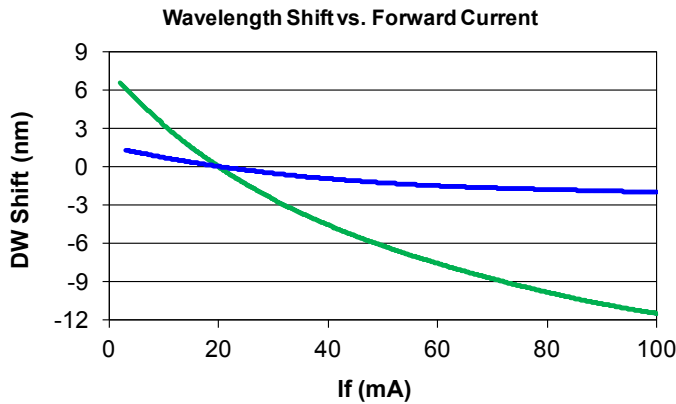
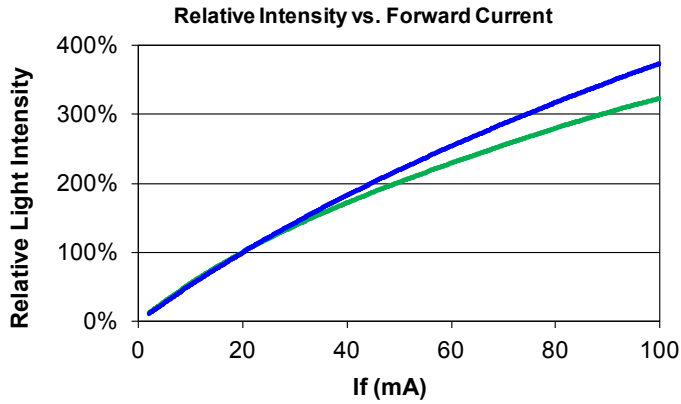

Radiation Pattern

This is a representative radiation pattern for the DA LED product. Actual patterns will vary slightly for each chip.

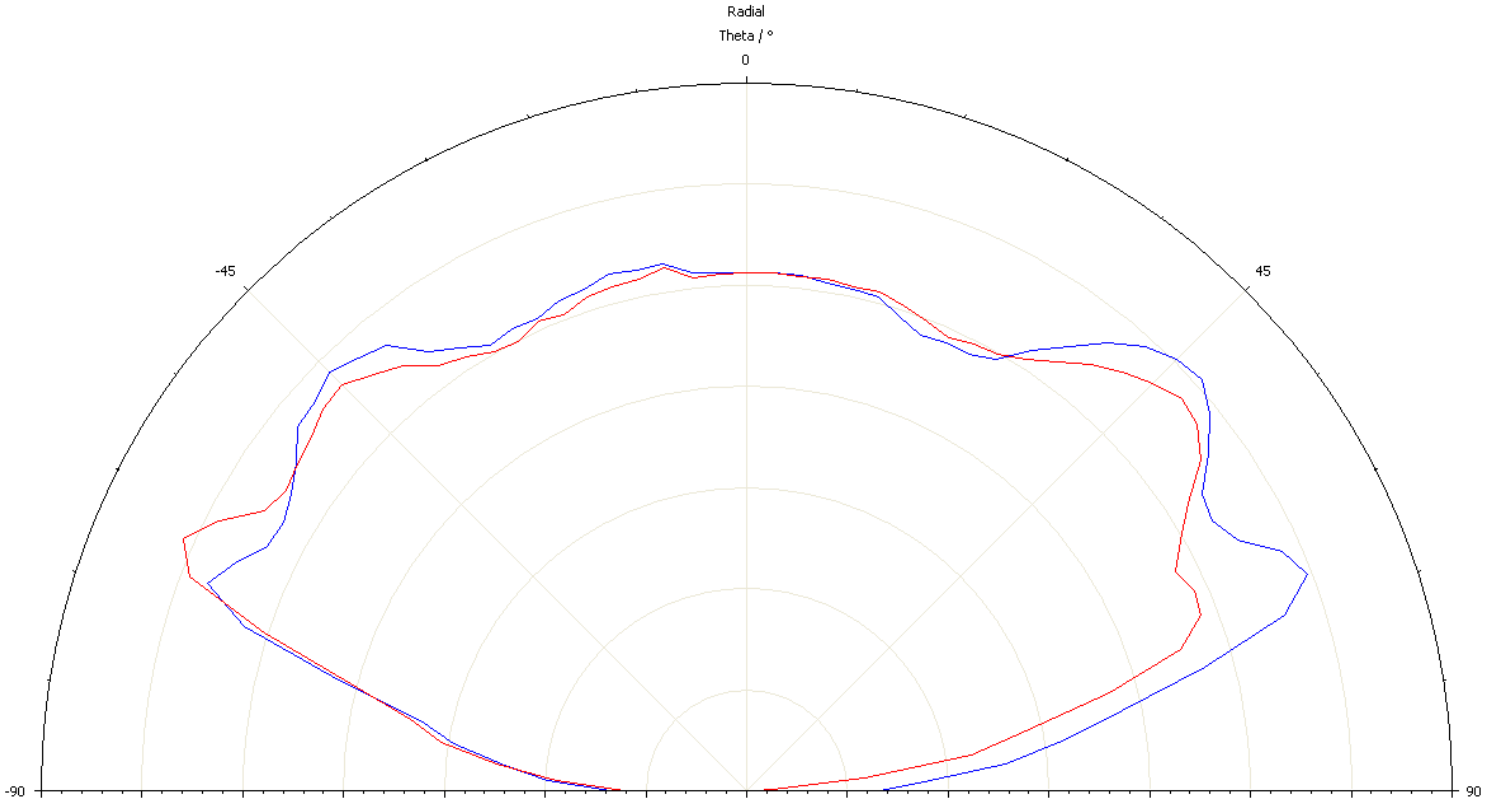

Product Content Information and Warnings

This information is not intended as legal advice. Consult a qualified lawyer if you are unfamiliar with the applicability of China RoHS 2 and/or California Proposition 65 to your business and products.

China RoHS 2

	<p>This green "e" logo is included on this product datasheet to indicate that the Cree product described herein does not include any of chemicals regulated under China RoHS 2 above permissible threshold limits. As applicable, each customer that incorporates this Cree product into its higher-level product needs to decide on the appropriate China RoHS 2 label for its higher-level product based on any other regulated content used in its product. If no other regulated content is present, this green "e" logo also may be used for the customer's product.</p>
---	---

Pursuant to Management Methods for Restricted Use of Hazardous Substances in Electrical and Electronic Products, an administrative order published by the Chinese Ministry of Industry and Information Technology (MIIT) and effective as of July 1, 2016 (more commonly known as "China RoHS 2"), electronic and electrical end products (EEPs) sold into China must be marked with a logo to indicate whether or not they contain any of the chemicals regulated under China RoHS 2 (i.e., lead, mercury, cadmium, hexavalent chromium, polybrominated biphenyls, or polybrominated diphenyl ethers) above the permissible threshold limits. As of March 2018, the list of EEPs includes refrigerators, air conditioners, washing machines, water heaters, printers, copiers, fax machines, TV sets, monitors, microcomputers, cell phones, and telephones. This list is subject to modification by the MIIT.

According to MIIT guidance, suppliers supporting the manufacture of EEPs (i.e., component suppliers) may—but are not required to—include a label on their component products. However, if a component product includes one of the regulated substances, the component supplier must provide the purchaser with information in a prescribed tabular format to facilitate labeling EEPs. The table must disclose the type and location of the hazardous substances contained in the component product. If a component product that could be used in an EEP is sold separately in the market, the component product falls within the scope of China RoHS unless the final purpose is known to be out of scope. A supplier that does not directly sell products in China should nevertheless comply with China RoHS 2 if there is a possibility that its products or products incorporating its products will be sold in China. For more information about China RoHS, please refer to <http://www.chinarohs.com/docs.html>.

California Proposition 65 Warnings

This Cree semiconductor die product (excluding packaging) does not contain any chemicals that must be disclosed under California Proposition 65 (officially titled the Safe Drinking Water and Toxic Enforcement Act of 1986, codified at Cal. Health & Saf. Code §§ 25249.5–.13) enacted by the State of California. This die product, however, is packaged using PVC die transfer film that contains Diisononyl Phthalate (DINP), a chemical known to the State of California to cause cancer and/or birth defects or other reproductive harm. If you are located in the State of California, the presence of DINP in the PVC die transfer film results in the need for you to provide an occupational warning under Proposition 65. Pursuant to California Health and Safety Code § 25606, you must post Proposition 65 compliant warnings at your place(s) of business in California to warn your employees and contractors who may come into contact with the PVC die transfer film during use and handling of the Cree die products, including in connection with the development or manufacture of higher-level products. Specifically, for indoor environments or outdoor spaces with clearly defined entrances, a warning sign must be posted at all public entrances to the affected area and, in no smaller than 72-point type, read substantially as follows:

	<p>WARNING: Entering this area may expose you to Diisononyl Phthalate (DINP), a chemical known to the State of California to cause cancer and birth defects or other reproductive harm. DINP is present in the PVC die transfer film on which certain semiconductor die products sold by Cree, Inc. or one of its affiliates are delivered. Please refer to the Cree website at www.cree.com/prop65-creecomponents to verify which Cree semiconductor die products are delivered on this type of PVC die transfer film. For more information on California's Proposition 65 warnings, go to www.P65Warnings.ca.gov.</p>
---	--

This occupational warning must be provided in English and in any other language used on other signage in the affected area. Since the Cree die products themselves do not contain DINP, their incorporation into your products will not create an obligation for you to include a Proposition 65 warning on your products. Please ensure that the PVC die transfer film is properly handled and properly disposed of as a hazardous material after die removal.

Please refer to the Cree website at www.cree.com/prop65-creecomponents to verify which Cree semiconductor die products are delivered on this type of PVC die transfer film.