

LA KP120U8F

135° Ultraviolet (275 nm) aluminum reflector LED

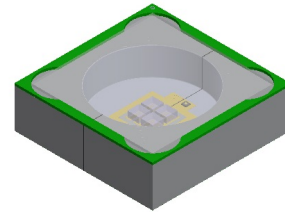

Light Avenue's aluminum reflector LED series is a UV LED package based on an aluminum reflector with a peak wavelength of 365 nm. The LED is protected with a transparent quartz glass that maximizes light output. The LED is optimized for best performance vs. price ratio and offers good thermal and reliability behavior. A protection diode offers Class 2 ESD Classification.



Features

- Peak wavelength 275 nm
- Aluminum SMT package
- Radiant power typ. 45 mW
- ESD protection diode

Applications

- Disinfection
- Sterilization
- Spectroscopy
- Sensors

Delineation

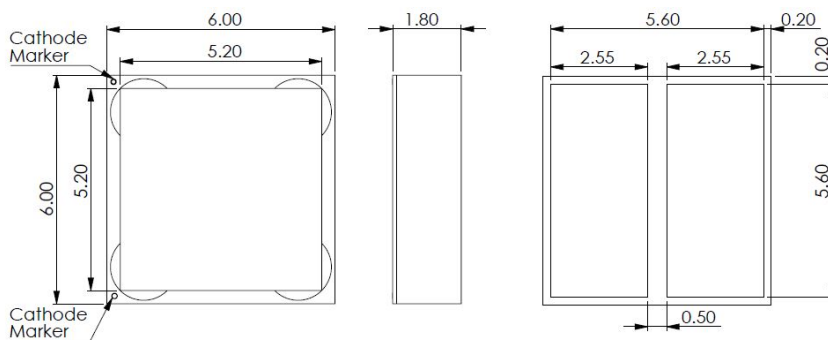

All dimensions in mm. Tolerance +/- 0.2 mm, if not otherwise specified.

Ordering information

| TYPE | PEAK WAVELENGTH | RADIANT POWER |
|--------------------|-----------------|---------------|
| LA KP120U8F-000303 | 270 ... 280 nm | 30 ... 70 mW |

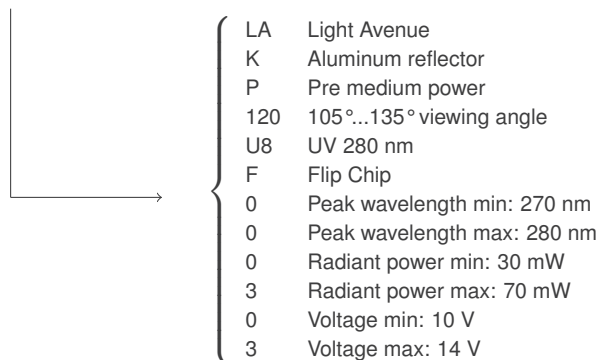

LA KP120U8F

135° Ultraviolet (275 nm) aluminum reflector LED



Electro-optical characteristics ($T_A = 25^\circ\text{C}$)²

| PARAMETER | SYMBOL | CONDITION | MIN. | TYP. ¹ | MAX. | UNIT |
|-----------------------|-------------------------|-----------------------|------|-------------------|------|------|
| Radiant power | Φ_e | $I_F = 200\text{ mA}$ | 30 | 45 | 70 | mW |
| Forward voltage | V_F | $I_F = 200\text{ mA}$ | 10 | 11.7 | 14 | V |
| Peak wavelength | λ_{peak} | $I_F = 200\text{ mA}$ | 270 | 275 | 280 | nm |
| Spectral width | RMS | $I_F = 200\text{ mA}$ | | 11.5 | | nm |
| Beam divergence angle | Θ | $I_F = 200\text{ mA}$ | | 135 | | ° |

Maximum ratings ($T_A = 25^\circ\text{C}$)³

| PARAMETER | SYMBOL | CONDITION | MINIMUM | MAXIMUM | UNIT |
|-----------------------------|--------------------|-----------|---------|------------------------------------|------|
| Operating current | $I_{f,\text{max}}$ | | | 250 | mA |
| Operating temperature range | T_{op} | | -40 | 80 | °C |
| Storage temperature | T_{st} | | -40 | 100 | °C |
| Reverse voltage | V_R | | | not designed for reverse operation | |
| Power consumption | P_{tot} | | | 2.98 | mW |
| Junction temperature | T_j | | | 85 | °C |

Binning ($I_F = 200\text{ mA}$)

| PEAK WAVELENGTH (NM) | | | RADIANT POWER (MW) | | | VOLTAGE (V) | | |
|-------------------------|------|------|-----------------------|------|------|----------------|------|------|
| Bin | Min. | Max. | Bin | Min. | Max. | Bin | Min. | Max. |
| 0 | 270 | 280 | 0 | 30 | 40 | 0 | 10 | 11 |
| | | | 1 | 40 | 50 | 1 | 11 | 12 |
| | | | 2 | 50 | 60 | 2 | 12 | 13 |
| | | | 3 | 60 | 70 | 3 | 13 | 14 |

LA KP120U8F

135° Ultraviolet (275 nm) aluminum reflector LED



Typical characteristics graphs

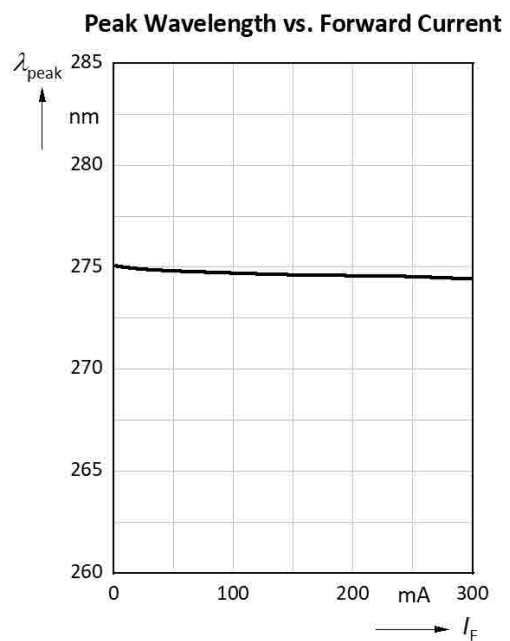
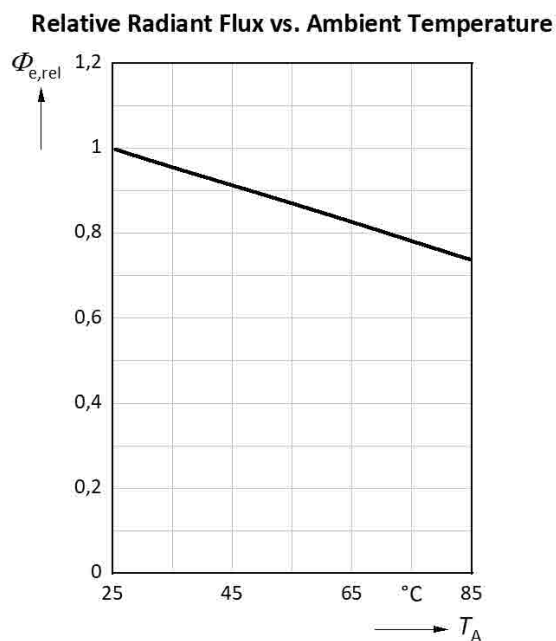
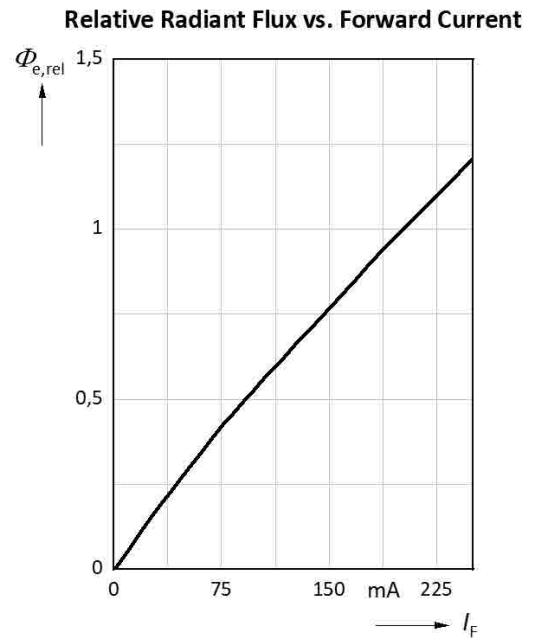
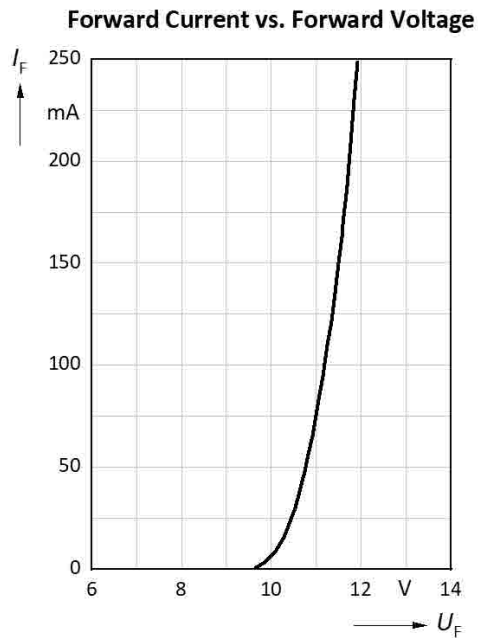

LA KP120U8F

135° Ultraviolet (275 nm) aluminum reflector LED



Spectrum (Relative Intensity vs. Wavelength)

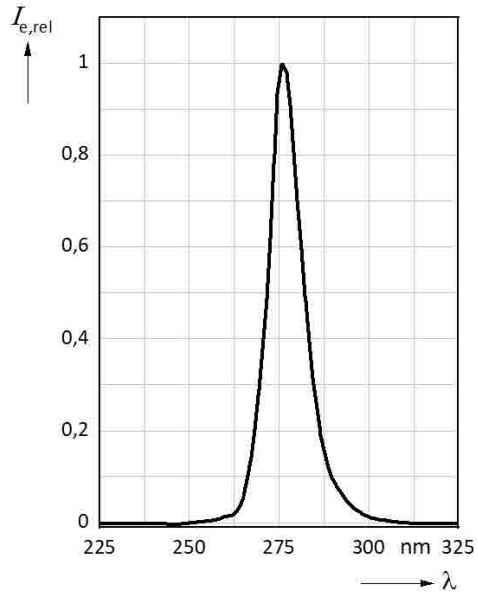

Typical Spatial Distribution (Relative Intensity vs. Viewing Angle)

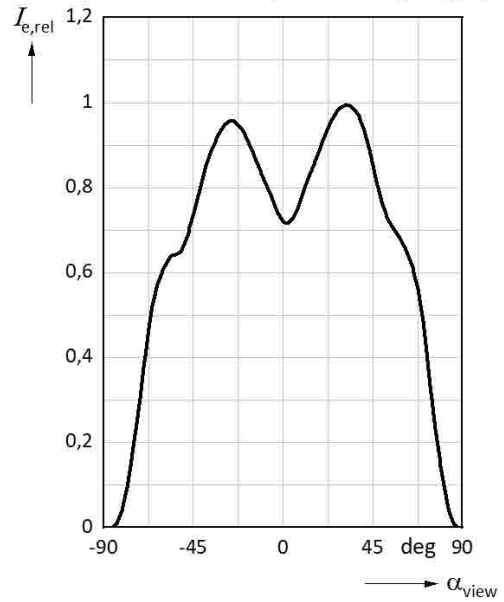

LA KP120U8F

135° Ultraviolet (275 nm) aluminum reflector LED



Thermal characteristics

| PARAMETER | SYMBOL | VALUE | UNIT |
|-------------------------------------|-------------------|-------|------|
| Thermal resistance junction ambient | $R\Theta_{JA}$ | 18 | K/W |
| Soldering temperature | T_{sold} | 260 | °C |

Recommended solderpad

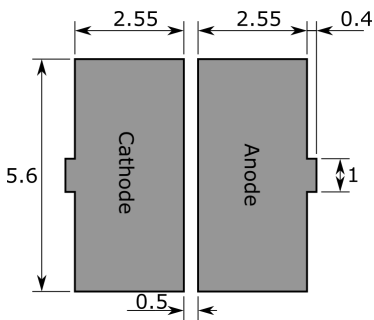

All dimensions in mm. Tolerance +/- 0.2 mm, if not otherwise specified.

Soldering

Soldering Profile (Temperature vs. Time)

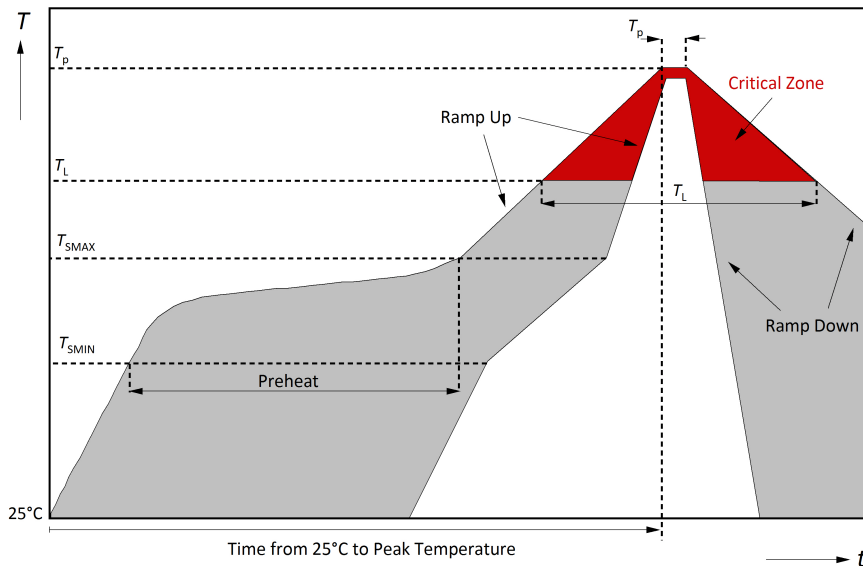

LA KP120U8F

135° Ultraviolet (275 nm) aluminum reflector LED



Recommended reflow soldering conditions following IPS/JEDEC J-STD-020.

| Pb-FREE ASSEMBLY | CONDITION | VALUE | UNIT |
|---|---|----------|------|
| Ramp-Up rate from T_{Smax} to T_P | $T_{Smax} = 200\text{ °C}$; $T_P = 260\text{ °C}$ | 3 | °C/s |
| Preheat between T_{Smin} and T_{Smax} | $T_{Smin} = 150\text{ °C}$; $T_{Smax} = 200\text{ °C}$ | 60...180 | s |
| Temperature maintained above T_L | $T_L = 217\text{ °C}$ | 60...150 | s |
| Peak temperature T_P | | 260 | °C |
| Time within 5°C of actual peak temp. | | 20-40 | s |
| Maximum Ramp-Down rate | | 6 | °C/s |
| Maximum time from 25°C to T_P | $T_P = 260\text{ °C}$ | 8 | min |

Actual solder profile may vary from the example given, and is very much depending on wave type, machine configuration, geometrical configuration, board shape etc. It is strongly recommended to optimize and evaluate the actual soldering conditions carefully for each individual project before releasing the soldering process. All temperatures refer to the topside of the package. The LED is designed to be reflow soldered. Hand or dip soldering is not recommended and also not suitable for this package. Reflow soldering must not be done more than two times. When the LED PKG is cooled at the maximum temperature, a rapid temperature fall is not recommended.

Important usage and application informations

Lead free product - RoHS compliant.

All products, product specifications and data to improve reliability, function, design or otherwise are subject to change without notice. The information describes the type of component and shall not be considered as assured characteristics. Due to technical requirements components may contain dangerous substances. For information on the types in question please contact our Sales Organization.

Caution – UV radiation!

The light output of the products may cause injuries to human eyes in circumstances where the products are viewed directly with unshielded eyes. LEDs can emit highly concentrated light which can be hazardous to the human eye. Products which incorporate these devices have to follow the safety precautions given in IEC 60825-1 and IEC 62471. Ultraviolet products emit high energetic light. Exposure to light with strong ultraviolet light can cause damage to the human eye and skin. Do not look directly or indirectly at ultraviolet light. If exposure to ultraviolet light is unavoidable, the body should be protected by suitable protection devices such as goggles and clothing.

Handling and storage conditions

Please be careful when handling the products, particularly if an over-voltage exceeds the maximum rating. The overflow in energy may cause damage to the products. In addition these products are sensitive to static electricity. Customers have to take care when handling the products to ensure that the handling process is fully protected against static generation. Ensure that products are grounded and that the facility has conductive mats, antistatic uniforms and shoes. Antistatic

containers are considered to be a good insurance against static electricity. The soldering iron point should be properly grounded. An atmospheric ionizer is recommended for use in the facility where static could be generated. Storage ambient conditions for all LEDs in sealed packages must be within $T_a = 10 \dots 40^\circ\text{C}$ and relative humidity $< 60\%$. LEDs in opened packages must be used within 2 weeks after opening. Storage time under the conditions above in sealed packages must not exceed 24 months. It is recommended to do a heat treatment of the LEDs before soldering. The baking should be at $65 \pm 5^\circ\text{C}$ for 10 to 24 hours. Humidity in this case should not exceed 10% relative humidity. When handling the LED with tweezers, please take it in a direction parallel to the electrode separation line. Do not touch the quartz glass. Do not do rapid cooling immediately after soldering. It can cause the LED to fail.

Packing

LEDs are packaged automatically on reels and packed into paperboard containers. Labels for identification are placed on the box. The label shows company name and address, LED type, quantity and lot number. The box is hermetically sealed in a plastic bag for shipment.

Returns and complaints

For complaints and returns of material a RMA-number is necessary. Samples for analysis purposes can be send to us without credit.

Shipping conditions

If not otherwise arranged, the "General Terms of Business of Light Avenue GmbH" apply for any shipment. If this document is not familiar to you, please request it at our nearest sales office.

Disclaimer

Attention please!

- **Components used in life-support devices or systems must be expressly authorized for such purpose!**

Critical components⁴ may only be used in life-support devices⁵ or systems with the express written approval by us.

- All products, product specifications and data to improve reliability, function, design or otherwise are subject to change without notice .
- Light Avenue GmbH, its affiliates, agents, and employees, and all persons acting on its or their behalf, disclaim any and all liability for any errors, inaccuracies or incompleteness contained in any datasheet or in any other disclosure relating to any product. Light Avenue makes no warranty, representation or guarantee regarding the suitability of the products for any particular purpose or the continuing production of any product. To the maximum extent permitted by applicable law, Light Avenue disclaims (i) any and all liability arising out of the application or use of any product, (ii) any and all liability, including without limitation special, consequential or incidental damages, and (iii) any and all implied warranties, including warranties of fitness for particular purpose, non-infringement and merchantability. Statements regarding the suitability of products for certain types of applications are based on Light Avenue's knowledge of typical requirements that are often placed on Light Avenue's products in generic applications. Such statements are not binding statements about the suitability of products for a particular application. It is the customer's responsibility to validate that a particular product with the properties described in the product specification is suitable for use in a particular application. Parameters provided in datasheets and/or specifications may vary in different applications and performance may vary over time. All operating parameters, including typical parameters, must be validated for each customer application by the customer's technical experts. Product specifications do not expand or otherwise modify Light Avenue's terms and conditions of business, including but not limited to the warranty expressed therein. Except as expressly indicated in writing, Light Avenue's products are not designed for use in medical, life-saving, or life-sustaining applications or for any other application in which the failure of the Light Avenue product could result in personal injury or death. Customers using or selling Light Avenue products not expressly indicated for use in such applications do so at their own risk. Please contact authorized Light Avenue personnel to obtain written terms and conditions regarding products designed for such applications. No license, express or implied, by estoppel or otherwise, to any intellectual property rights is granted by this document or by any conduct of Light Avenue. Product names and markings noted herein may be trademarks of their respective owners.
- The information describes the type of component and shall not be considered as assured characteristics. Due to technical requirements components may contain dangerous substances. For information on the types in question please contact our Sales Organization.
- Lead free product - RoHS compliant.
- The quality level of the final visual inspection shall comply to an AQL of 1.0 (according to MIL-STD-105E, level II), if the customer performs an incoming visual inspection of a shipment.

LA KP120U8F

135° Ultraviolet (275 nm) aluminum reflector LED



- All chips are checked according to the producer's specification of the visual inspection. If this document is not familiar to you, please request it at our nearest sales office.

Changes

| VERSION | DATE | CONTENT |
|---------|------------|---|
| 1.0 | 25.06.2020 | Change management has started, technical graphs have been added (page 3-4). |
| 2.0 | 18.01.2022 | New address. |

Published by:
Light Avenue GmbH
Am Kuehlen Kasten 8
93161 Sinzing
Germany
www.light-avenue.com
info@light-avenue.com
© All Rights Reserved

¹Due to the special conditions of the manufacturing processes of LED, the typical data or calculated correlations of technical parameters can only reflect statistical figures. These do not necessarily correspond to the actual parameters of each single product, which could differ from the typical data and calculated correlations or the typical characteristic line. If requested, e.g. because of technical improvements, these typ. data will be changed without any further notice.

²Measurements are done with an accuracy of $\pm 15\%$. Correlation to customer's equipment and products is required.

³Maximum ratings are package dependent and may differ between packages. The forward current is not limited by the die but by the effect of the LED junction temperature on the package. If you need more information on pulsed operation, please contact your next sales office about possible driving conditions. If not otherwise specified the maximum pulse current may not exceed the maximum current in continuous mode.

⁴A critical component is a component used in a life-support device or system whose failure can reasonably be expected to cause the failure of that life-support device or system, or to affect its safety or the effectiveness of that device or system.

⁵Life support devices or systems are intended(a) to be implanted in the human body, or(b) to support and/or maintain and sustain human life. If they fail, it is reasonable to assume that the health and the life of the user may be endangered.